

LemTech

Lemtech Holdings Co., Limited

LemTech Holdings Co.,Ltd

*Leading **E**ngineering & **M**anufacturing **T**echnology*

2015 Performance Report



Content

- Corporate Profile
- Core Business Activities
 - Tooling & Design Capabilities
 - Stamping Solutions in Mobile
 - Automotive Business
 - Thermal Solution in 3C Products
 - New Thermal Technology for Servers
 - Slide Rails for enterprise Servers
- Our Valued Customers
- Financial Report

- 提供的產品及服務包含：
 精密模具、金屬沖壓、
 專業客製化的散熱模組
 鉸鏈/滑軌、給消費型電子產品、
 伺服器產品、車用產品、
 建築產品等等
- 全球四個國家設有營運據點及工廠
- 2011年正式在櫃檯買賣中心掛牌交易
- 2014年集團營額突破1億美元
- 2015年在臺灣證券交易所上市掛牌





• **TAIWAN**
★ Taipei (HQ)

• **CHINA**
★ Taiwan
• KunShan
• Hong Kong

• **THAILAND**
• Ayutthaya

• **USA**
• San Jose, CA

•• **5 Manufacturing Sites/Offices**
• ~ Total Floor Space: 500,000 sqft

Core Business Activities

Product Design Platforms

3D : Solidworks/pro-E

2D : AutoCad

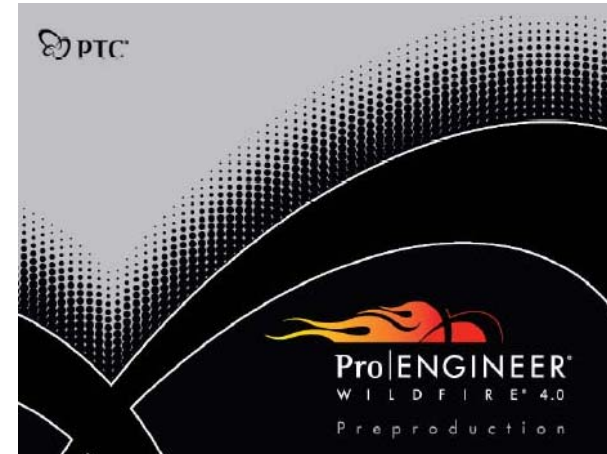
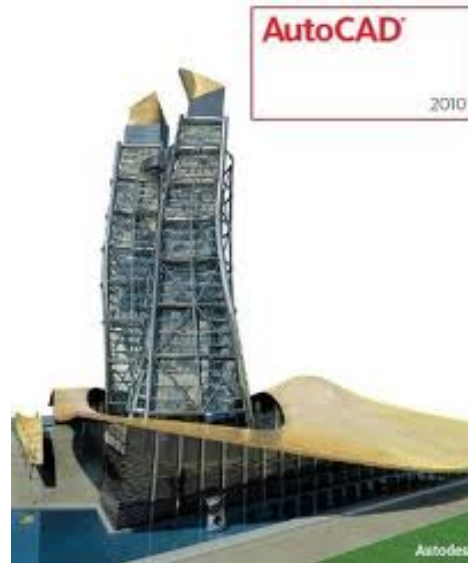

Tool Design Platforms

3D : Key creator

2D : PressCad

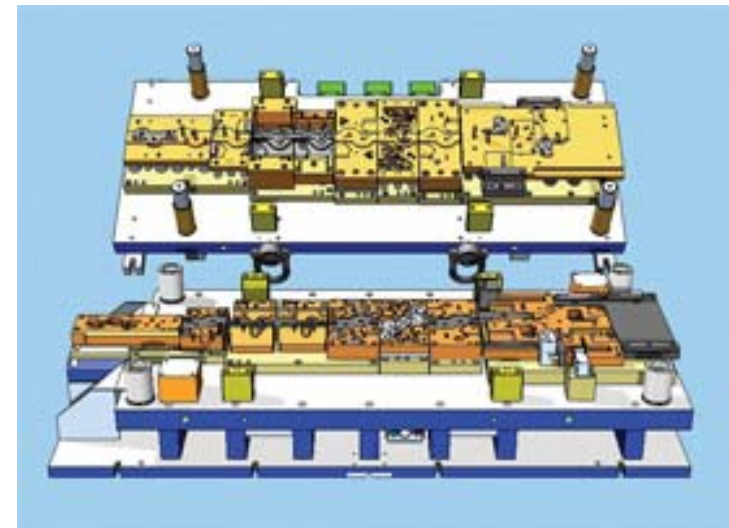
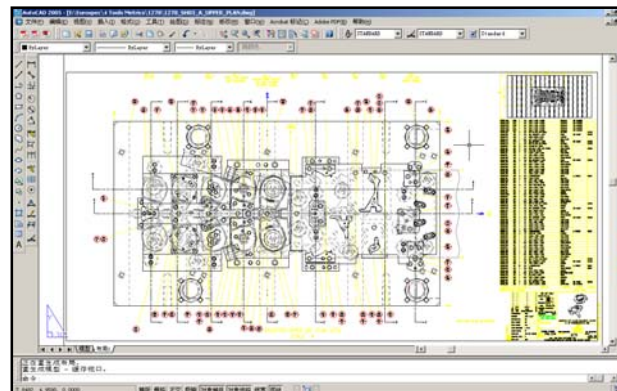

Tool Room Equipment 模具加工母機



CNC Wire EDM Area



AgieCharmilles - Wire EDM



Surface Grinders



Horizontal CNC Machining Center



Vertical CNC Machining Center

消費型電子產品零件

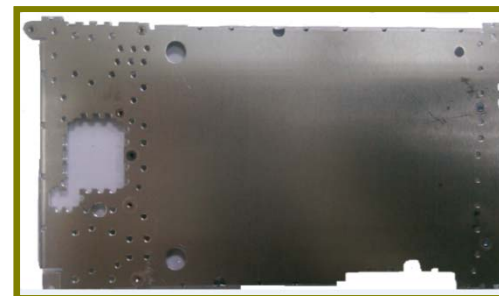
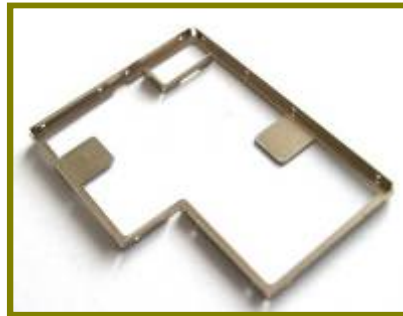

行動電話系列之電源/音量/耳機



耳機環



音量鍵



電源鍵

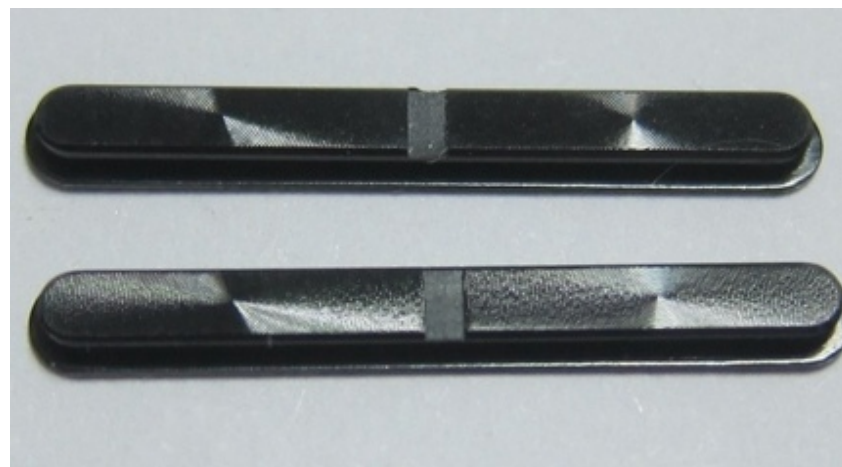

音量鍵

Parts For Various Automotive Applications

安全氣囊

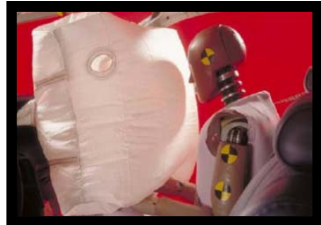

安全帶系統



車門鉸鍊



天窗及音響設備



消費性電子散熱產品

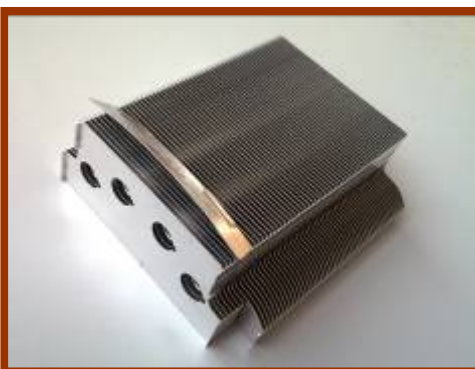
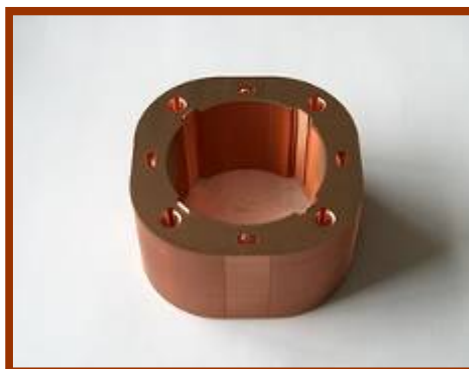

3C電子之散熱產品

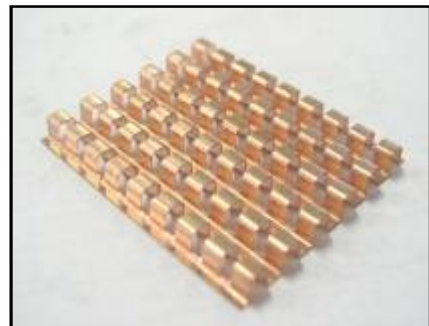
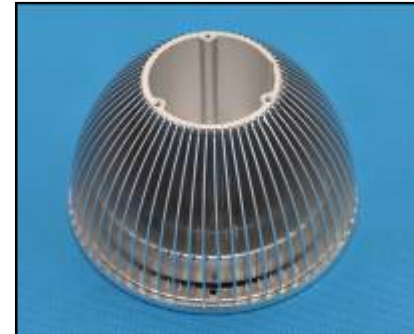

無焊接製程之散熱產品

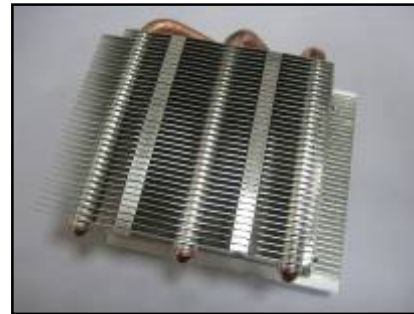
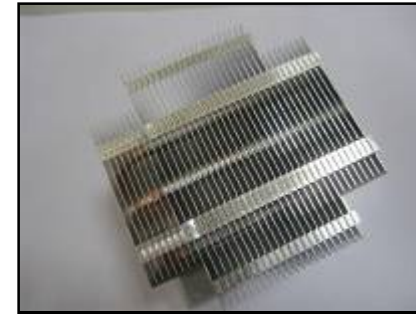
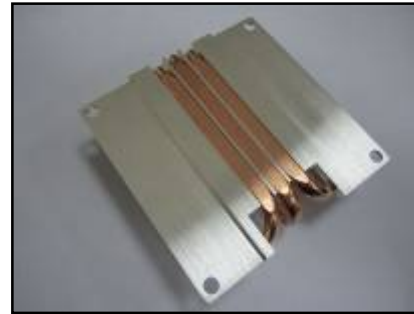

- 冷卻系統為雲端數據中心的關鍵系統，優良的冷卻系統可提供更低成本的建置與營運成本，同時可提高能源利用效率



•Source: <http://www.google.com/about/datacenters/>

- 冷卻系統所需電能為總營運電能之40%，高效率的散熱技術可減少能源需求
- 雲端數據中心的營運成本與冷卻風流量成正比，好的散熱技術可降低風流需求

散熱模流模擬軟體

SolidWorks Flow Simulation

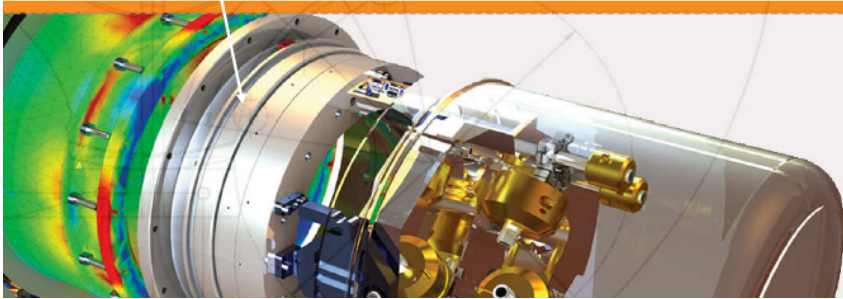

Icepak

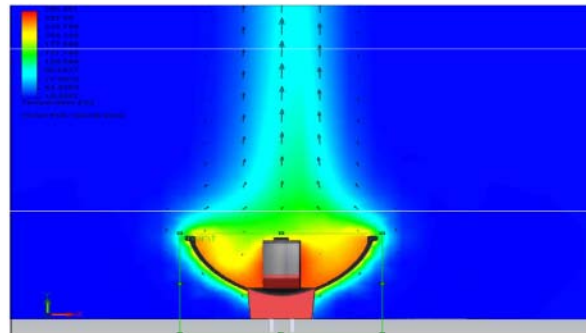
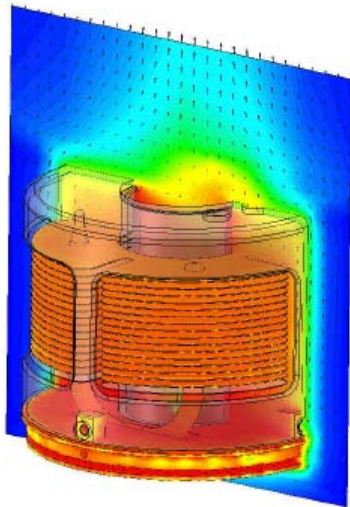
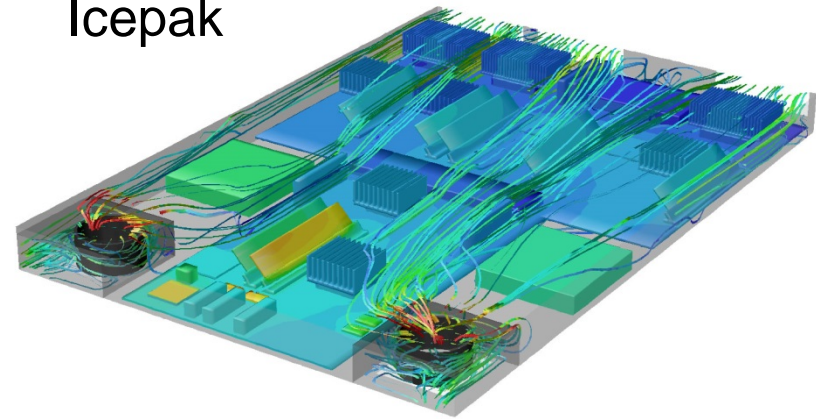

Flotherm

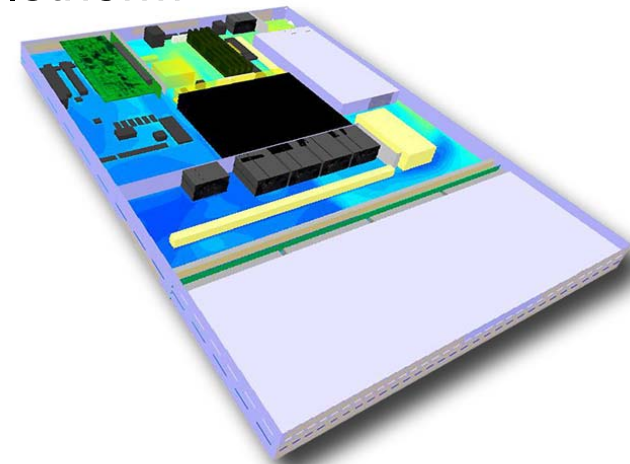

● 兼顧性能與成本之創新設計

- 自主循環、液氣兩相流、遠端冷凝之設計
- 降低重力對性能的影響
- 解決多重熱源之共平面問題
- 熱源與冷凝器的位置可彈性配置
- 可相容更高瓦數的CPU
- 大幅提升機箱內風流量的利用效率

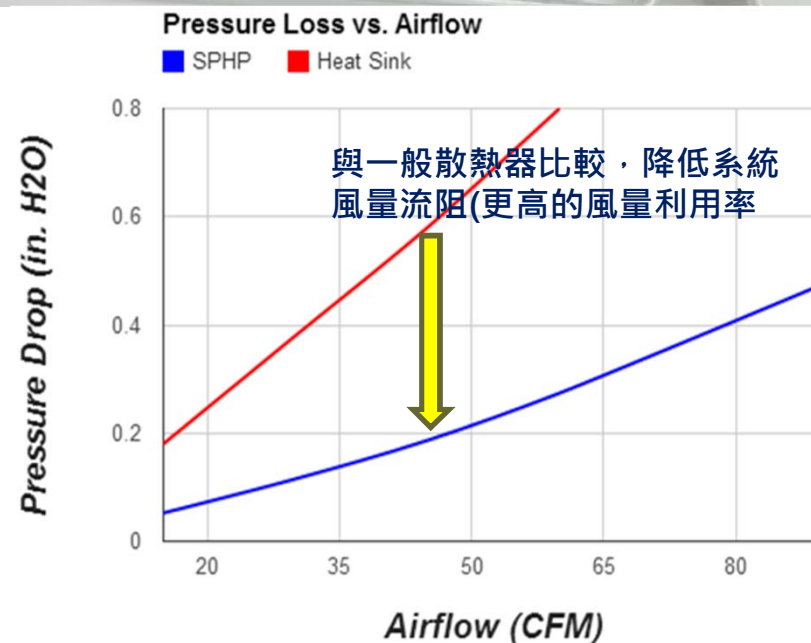
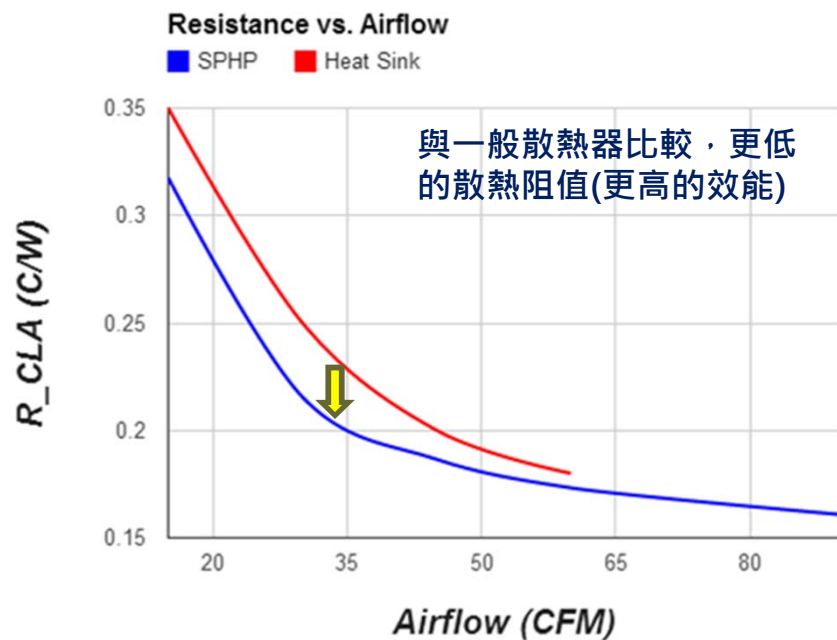

簡 介

- 適用業界標準19吋機架
- 滑軌長度：22" ~ 32"
- 承載 1U ~4U 伺服器
- 1 機架單位 (1U) = 1.75" = 44.45mm
- 承載率：2.5 倍最高系統重量

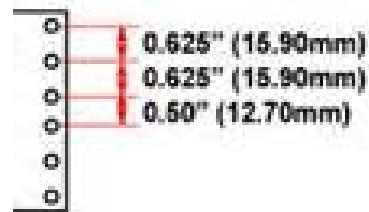

Wide angle view

業界標準 19 吋 機架

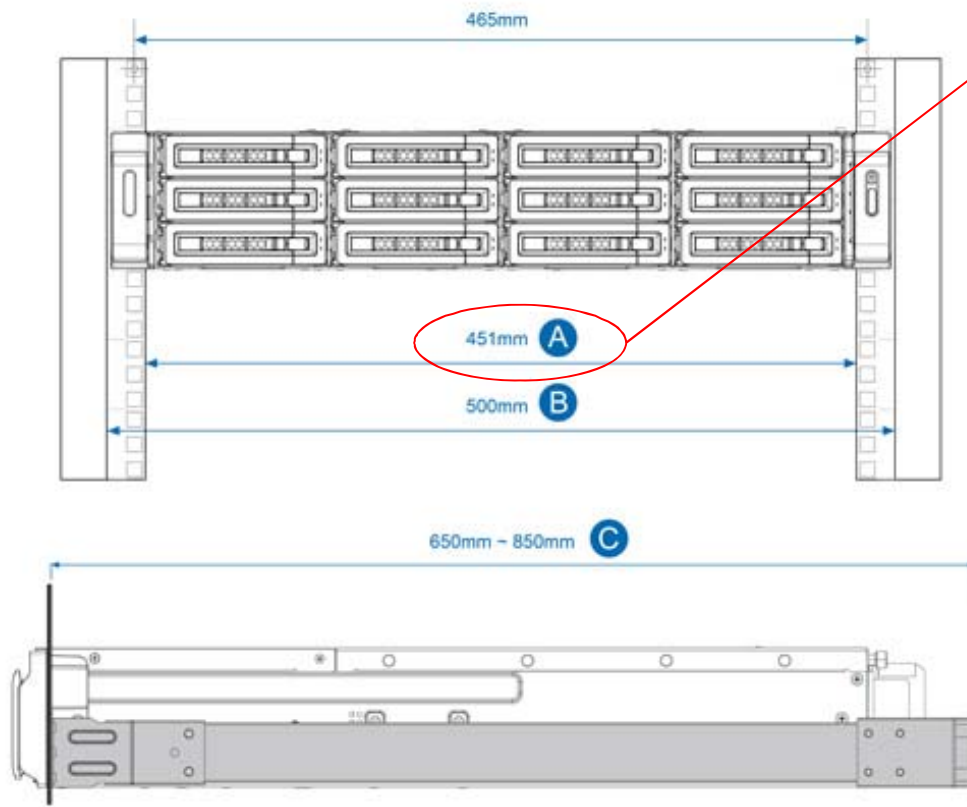

架臂兩端的寬度 (451mm) 為侷限所在. 滑軌的厚度形成決定伺服器機架的最大寬度.

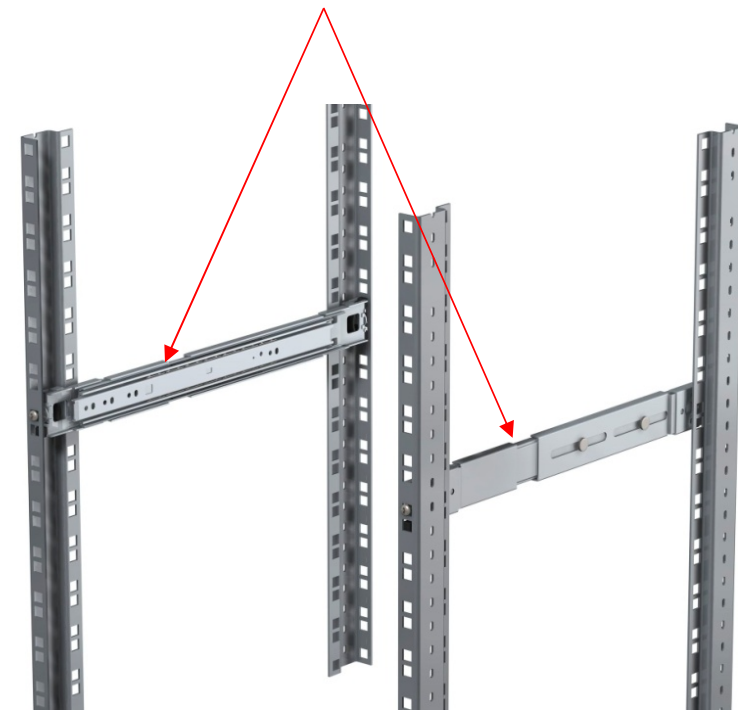

徒手式組裝設計

- 毋需使用工具即可將滑軌嵌槽置入 EIA 框緣
- 簡易手動即可拆解彈簧鎖扣
- 可彈性調整長度符合各式機架深度



正面組立圖



背面組立圖

各式機架組配界面

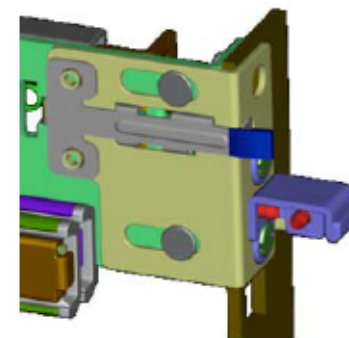
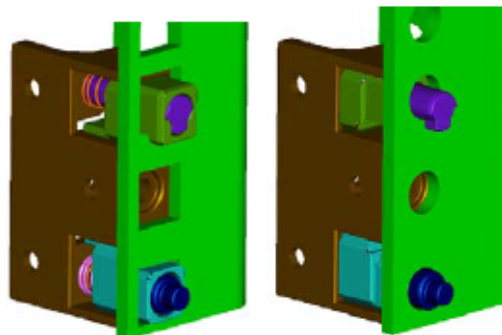
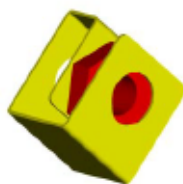
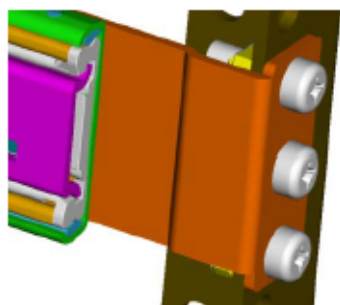
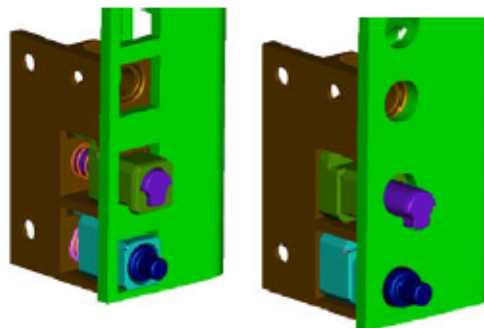
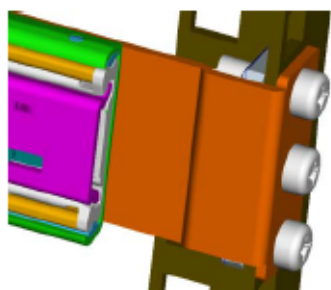

通用款
(使用嵌钩方式)

徒手式安裝
(利用三向設計, 適用圓形與方形接孔)

其它徒手式安裝

產品線開發方向 - 降低滑軌厚度, 同時還要維持現有滑軌的承載能力

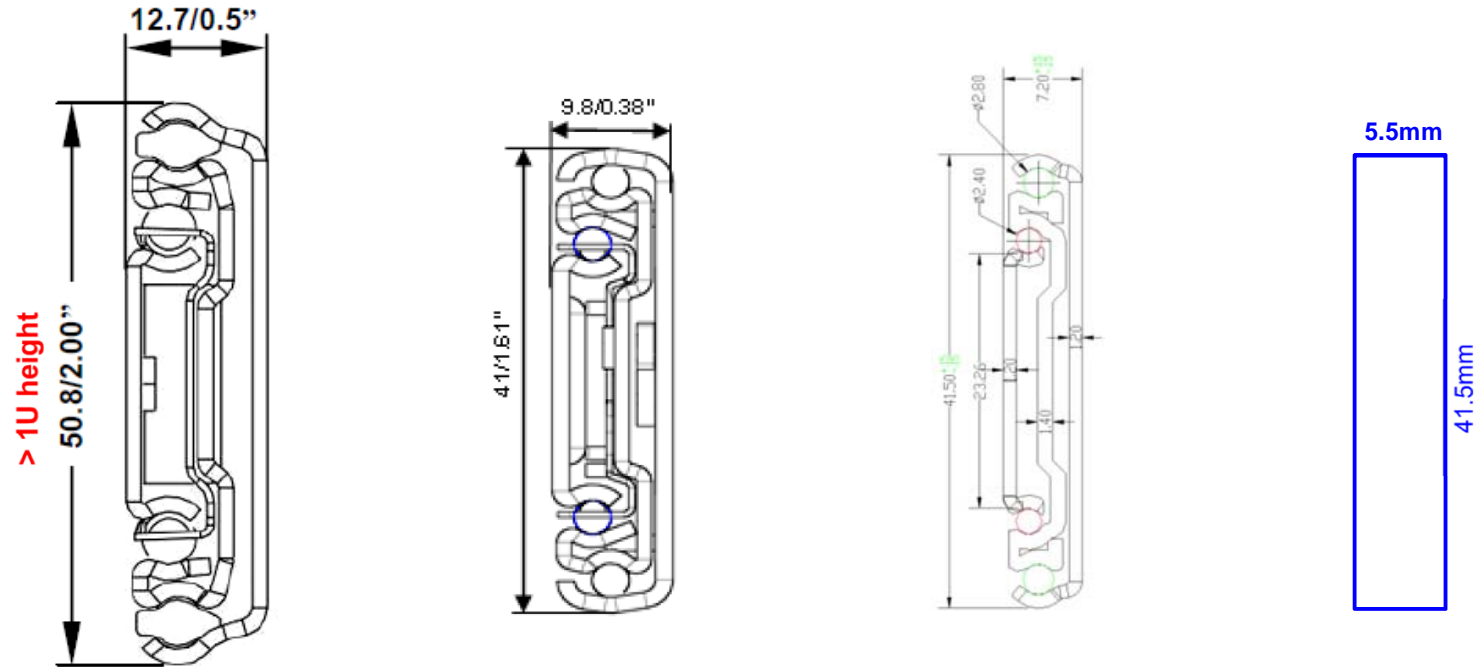

	< 2002	2002 to 2011	2012 to 2016	> 2016
Slide Thickness:	12.7mm → 24%	9.6mm → 25%	7.2mm → 24%	5.5mm
Suitable For:	1.5U to 5U	1U to 4U	1U to 4U	1U to 2U
Max System Weight:	80kg → 25%	60kg → 20%	48kg → 21%	38kg
Chassis Width:	< 434mm	< 434mm	434-436mm	< 440mm

產品開發流程

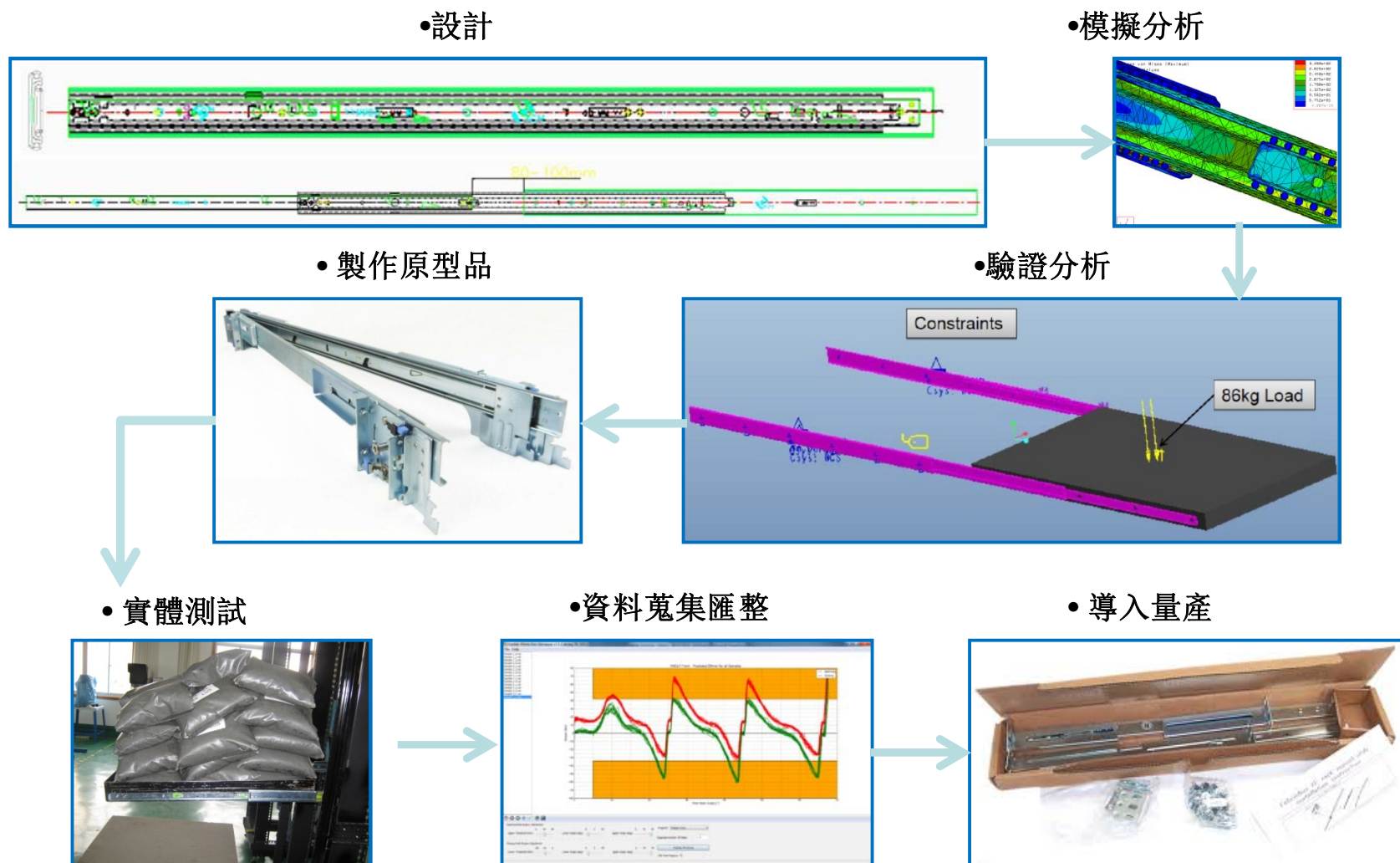

聯德滑軌製造經驗與優勢

- 聯德具有10年以上的伺服器滑軌設計及製造經驗
- 聯德自2002年起替國際大廠如Accuride及CIS等代工生產滑軌產品與零件的製造經驗.
- 具備90%以上滑軌零組件自製的能力

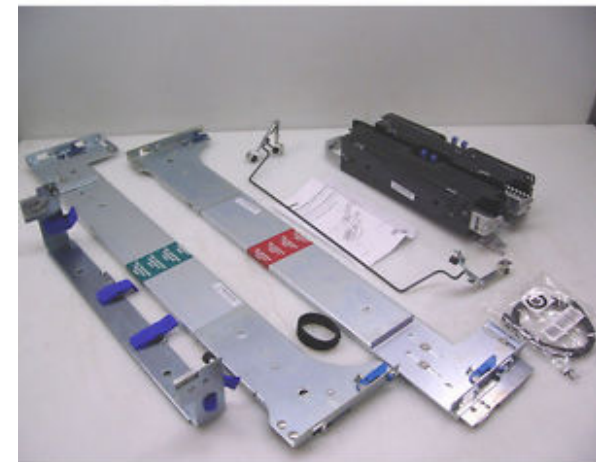

汽車產品客戶

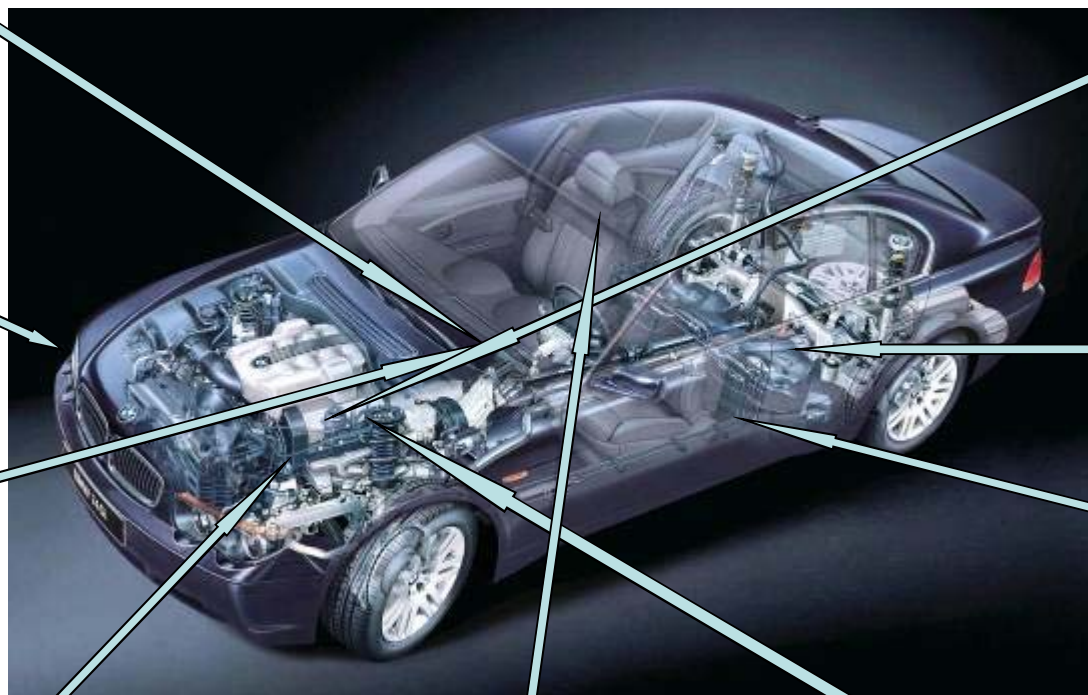

消費型電子產品客戶



LemTech

Lemtech Holdings Co., Limited

Financial Report

	2011年	2012年	2013年	2014年	2015年
流動資產	838,888	1,138,687	1,475,767	2,195,561	2,383,015
不動產、廠房及設備	273,974	361,709	569,940	604,325	701,618
其他資產	24,768	89,484	111,849	121,277	123,476
資產總額	1,137,630	1,589,880	2,157,556	2,921,163	3,208,109
流動負債	467,674	563,739	1,111,704	1,354,552	1,184,172
非流動負債	3,188	15,673	24,867	356,247	235,216
負債總額	470,862	579,412	1,136,571	1,710,799	1,419,388
權益總額	666,768	1,010,468	1,020,985	1,210,364	1,788,721

單位：新台幣仟元

	2011年	2012年	2013年	2014年	2015年
合併營收	1,159,513	1,932,714	2,114,891	3,068,330	2,927,364
銷貨毛利	282,777	473,326	471,451	718,530	723,739
營業淨利	139,229	249,841	171,669	343,068	301,927
稅後淨利	107,667	204,396	131,234	221,406	202,316
每股盈餘	4.01	7.24	4.00	6.73	5.19

		2011年	2012年	2013年	2014年	2015年
獲力能力	毛利率(%)	24.39	24.49	22.29	23.42	24.72
	費用率(%)	12.38	11.56	14.17	12.24	14.41
	營業利益率(%)	12.01	12.93	8.12	11.18	10.31
財務結構	負債比率(%)	41.39	36.44	52.68	58.57	44.24
	現金與約當現金 (仟元)	192,243	430,727	378,673	358,990	604,250
償債能力	流動比率(%)	179.37	204.59	132.75	162.09	201.24
	速動比率(%)	142.59	173.05	111.53	140.21	175.60
經營績效	應收款項週轉天數	131	96	106	97	116
	存貨週轉天數	52	41	44	39	47
	應付款項週轉天數	127	93	121	112	115

單位：新台幣仟元；%

主要產品	2011		2012		2013		2014		2015	
	銷值	%	銷值	%	銷值	%	銷值	%	銷值	%
3C電子類	767,700	66.21	1,370,297	70.90	1,331,346	62.95	2,013,689	65.63	1,756,201	59.99
汽車零件類	216,748	18.69	357,987	18.52	577,066	27.29	783,838	25.55	891,578	30.46
建築建材類	106,642	9.20	132,473	6.85	120,318	5.69	121,130	3.95	115,078	3.93
模具	68,423	5.90	71,957	3.72	86,161	4.07	149,673	4.88	164,507	5.62
合計	1,159,513	100.00	1,932,714	100.00	2,114,891	100.00	3,068,330	100.00	2,927,364	100.00

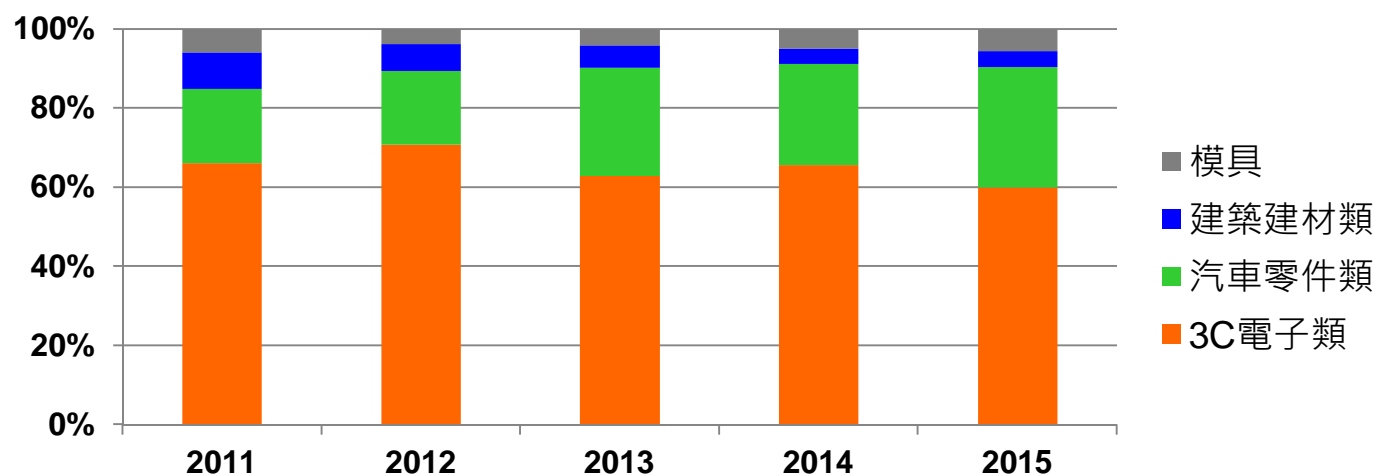

LemTech

Lemtech Holdings Co., Limited

LEMTECH

...Leading Engineering & Manufacturing Technology

Your Trusted Partner in Business

www.ky-lemtech.com

